

Fig. 5

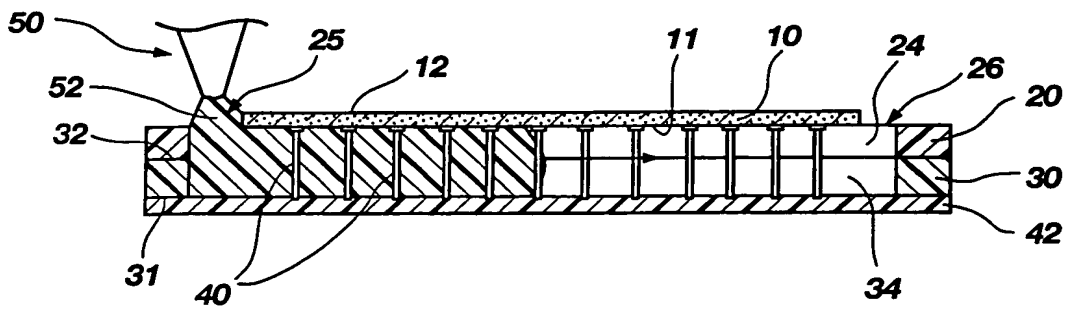

Fig. 6